



التقاء

DUBAI

BY R•EVOLUTION

YOUR HOME.
YOUR TREE OF LIFE.

Ready to Embrace the Extraordinary?

Welcome to the developer and creative force behind Eywa, R.Evolution. Since 1999, we've been dreaming the impossible into being – and winning awards while doing so.

- Having already developed more than 2,500,000 sq. ft. GFA of prime real estate in Latvia, Germany and Spain, Eywa introduces our signature style to Dubai.

International Award Winners



Energy
Youthfulness
Well-Being
Ancient Knowledge

البرقيع

DUBAI

BY R·EVOLUTION

48 Exclusive
Waterfront Residences

عيفا

DUBAI

BY R•EVOLUTION

WILD LUXURY

“Wild luxury” is a truly unique life experience designed for those who seek originality, shun conformity, and yearn for positivity, purity, and well-being in their home. By being close to nature, Eywa’s “Wild Luxury” design features enable residents to build a deeper, truer connection with their own selves.

At Eywa, science and spirituality intertwine. Here, tradition merges with technology, creating an experience of authentic depth, genuine value, and lasting impact.



Welcome to EYWA

A boutique building with 48 exclusive residences, designed to focus on the well-being of our community through environments that are close to nature and promote positive energy.

عاشق
DUBAI
BY R•EVOLUTION

Embrace Yourself With Architecture

We have a firm belief that, in the 21st century, possessing luxurious things should never be an end in and of itself.

More than just a place to live, Eywa is a unique way to live. A way of living that's organic and vivid, imaginative and all-enveloping. A way of living that will truly enrich your soul, your health and your well-being.



عقوة











DUBAI

BY R·EVOLUTION



EYWA MAIN ENTRANCE

Business Bay

-  Burj Khalifa 8 min.
-  Dubai Mall 8 min.
-  Dubai Opera 8 min.
-  The Dubai Fountain 8 min.
-  Jumeirah Beach and Palm Jumeirah 10 min.
-  Mall of the Emirates 10 min.
-  DIFC 12 min.
-  Dubai International Airport 15 min.
-  Dubai Marina 15 min.
-  Burj Al Arab 15 min.
-  Palm Jumeira 20 min.



DUBAI LOCATION

EYWA, Marasi Drive,
Business Bay, Dubai, UAE

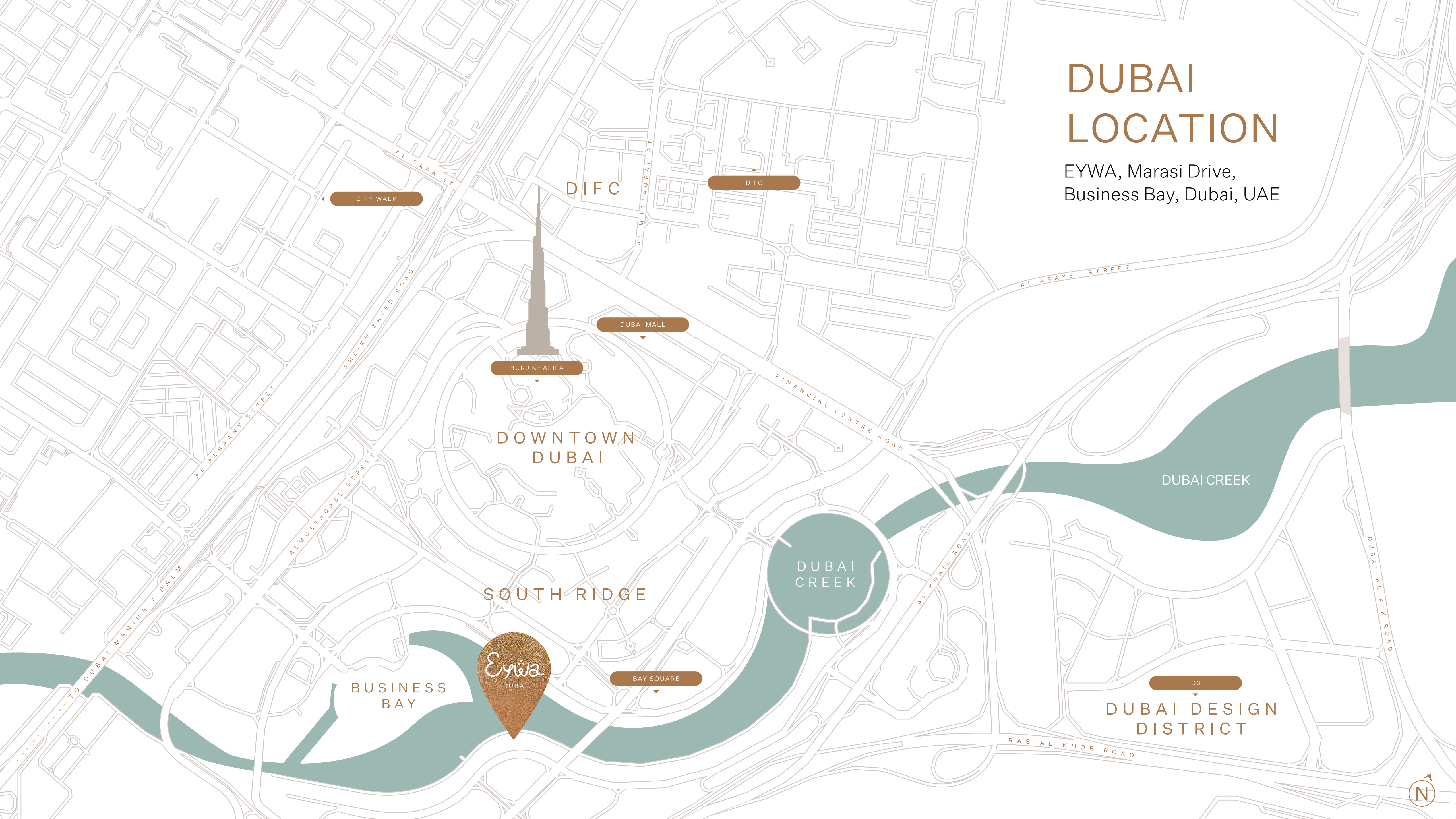

CITY WALK

DIFC

DIFC

BURJ KHALIFA

DUBAI MALL

DOWNTOWN
DUBAI

DUBAI CREEK

DUBAI
CREEK

SOUTH RIDGE

BUSINESS
BAY



BAY SQUARE

D3

DUBAI DESIGN
DISTRICT



عيفا

DUBAI

BY R•EVOLUTION



Tree of Life

Strikingly unique from your very first glimpse, Eywa instantly evokes a glorious Tree of Life. An organic canopy of branches, an enticing weave of roots, a floating oasis and a living breathing building that represents timeless wisdom and enduring growth.

Library

Often called the tree of knowledge and wisdom, the banyan tree represents growth, strength and self-awareness.

Step between the trunks of our tree, and you'll discover how Eywa celebrates, shares and nurtures knowledge.

Nestled there, within our main hall, is a community library. This features a lovingly curated collection of more than 2500 books, including a range of books from a wealth of international philosophers.



THE LOBBY LIBRARY

Eywa is a Breathing Organism

Interacting at all levels and through all senses

Eywa is a beautiful kinship between ancient science and wisdom, modern technology and world-class architecture.

Eywa combines the venerable design principles of Vastu Shastra with the latest technologies to harmonise the building's energies, and create an environment that supports your well-being and shapes a promise for modern life.

Flying Trees

Our vision is for Eywa to be a living organism, at one with nature and with its surroundings. From every angle, therefore, the building's façade appears to be alive with greenery.

Location of Stones

- The North West
Moon Stone
- The North
Lapis Lazuli
- The North East
Citrine
- The West
Black Tourmaline, Blue Sapphire
- The South
Jasper, Coral, Topaz, Carnelian, Red Garnet
- The East
Green Jade
- The South East
Rose Quartz
- The South West
Agate, Tiger's Eye
- The Central Part
Selenite, Clear Quartz

CRYSTAL PYRAMID WITHIN THE BUILDING.
POSITIONING OF THE STONES PER FLOOR.

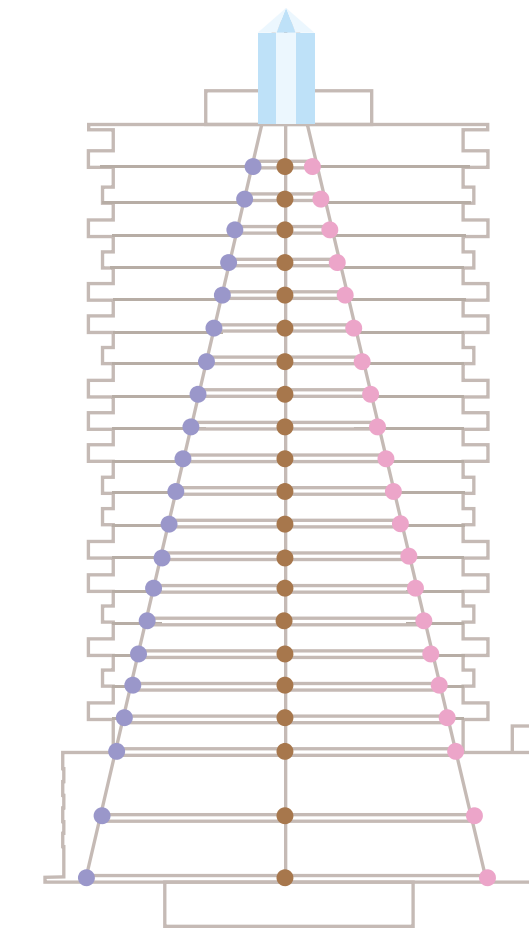

Front View

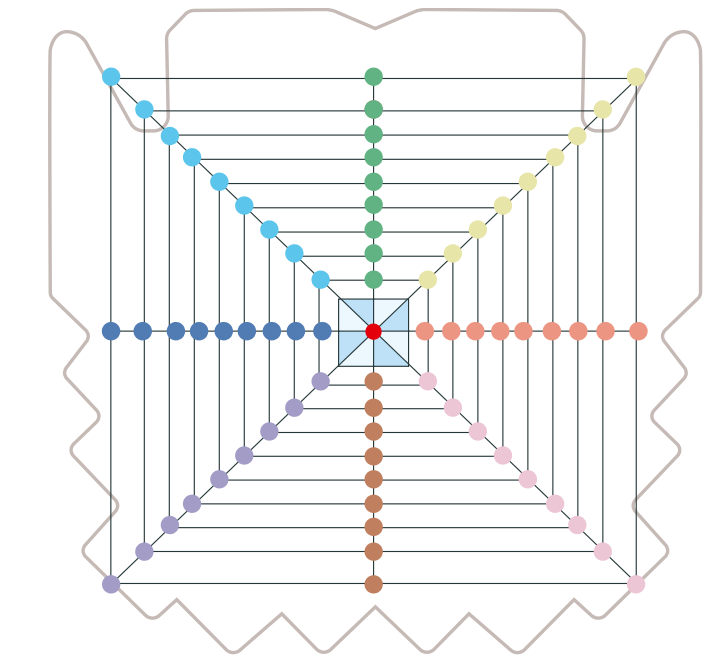

Top View

REPRESENTATION FOR
CRYSTALS TO BE IMPLANTED
IN THE COLUMNS

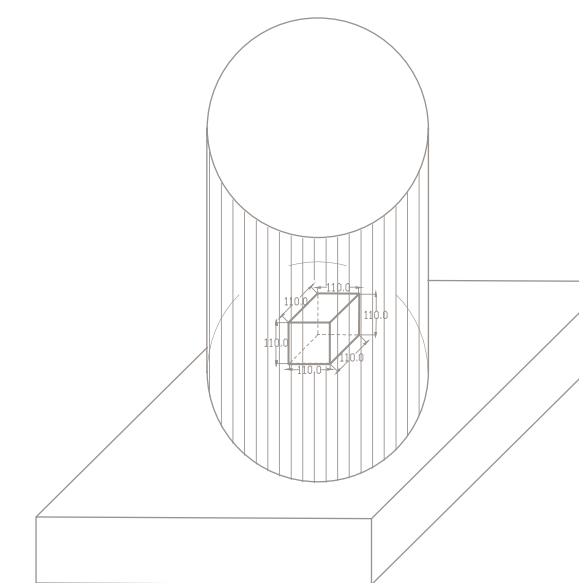

Isometric View

REPRESENTATION FOR
CRYSTALS TO BE IMPLANTED
IN THE CONCRETE SLAB

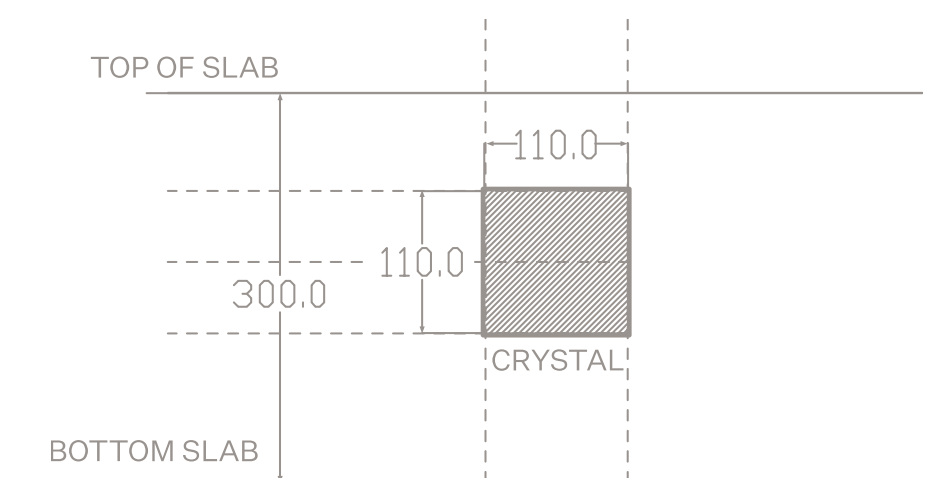

Top View



عناوين

DUBAI

BY R•EVOLUTION

INSIDE EYWA

عيفا

DUBAI

BY R•EVOLUTION



Eywa Apartment No.1

The Dedicated Residents' Community Space

From a chef's table and library to private waterfalls and hammocks, Eywa is packed with ideas, features and moments that are vibrantly different.

Most importantly, each and every one of these extraordinary life experiences is deliberately intended to augment your well-being, and touch your heart & senses — every day.

Throughout Eywa we've designed areas devoted to shared spaces and facilities.

Private Waterfalls, Pools & Gardens

Being at one with nature. Living in the here and now.
Accentuating our senses

These feelings and these moments matter. That's why
Eywa creates a strong connection with natural elements
throughout its community areas, and in each apartment.

From the rustle of leaves to the rush of water, in Eywa
you're never more than a step away from nature.

إيوا

DUBAI

BY R • EVOLUTION





Club House Dining

At Eywa, we passionately believe that food doesn't just enable life, health and growth. It enriches it. Eating together brings us together. Great food, drink and company is a timeless combination and enduring pleasure to life.

And – inspired by this truth – we've created an outstanding Club House and Restaurant for our community of residents and their guests. Quite simply, this is a dining experience unlike any other.



إيوا

DUBAI

BY R·EVOLUTION

CLUB HOUSE & RESTAURANT TERRACE

المنارة

DUBAI

BY R·EVOLUTION



CLUB HOUSE & RESTAURANT OPEN KITCHEN

Spa

At Eywa, our spa is a fully-integrated part of the experience, an essential element in your overall well-being, a calming and peaceful component to the Eywa way of life.

It's somewhere that will both stimulate and soothe, immerse and inspire.



عشيرة
DUBAI
BY R-EVOLUTION

SPA RECREATION AREA

Health & Well-Being Facilities

Eywa stretches and supports you — mind, body and spirit.

And because physical and mental well-being go hand-in-hand, we've made sure that this vital balance is abundantly available to you.



Eywa

DUBAI

BY R•EVOLUTION

The Movies

They fire the imagination and escapism. They create collective experiences and lasting memories. At Eywa, we love them – and we know you do too. That's why we've included two cinemas, just for our residents.

Playgrounds

At Eywa, we consider children to be among the most precious parts of our lives and our future.

That's why we've taken care to create conditions for your children's all-round development as versatile, spiritually developed personalities – and to ensure they will always be happy, entertained and fulfilled at Eywa.



Private Dining & Conference Rooms

Well-being thrives on harmony. And your work-life balance is an important ingredient in that mix.



PRIVATE DINING & CONFERENCE ROOM



Parking

Even our car parking spaces have a drive to be different, a touch of our signature “Wild luxury” style.

We don’t just provide four levels of parking, we’ve also designed them as an extension of your home, to maximize their outlook over the surrounding greenery and water.

- ◆ Parking with • Drivers’ Lounge
- ◆ Open for Natural Ventilation
- ◆ EV Charging Stations
- ◆ Valet Carts
- ◆ Bicycle Parking and Maintenance



المنارة

DUBAI

BY R•EVOLUTION

APARTMENTS

Project Details

46

Exclusive
Residences

2

Luxury
Penthouses

142

Parking
Spaces

G + 3P + 19

Storeys

Residence Sizes

3,064 sq ft - 16,256 sq ft

Residence Types

11

2-Bedroom
Apartments

22

3-Bedroom
Apartments

9

4-Bedroom
Apartments

6

5-Bedroom
Apartments

48

Residential
Units

Step into the World of Eywa

Inside Eywa is a carefully selected mix of 2, 3, 4 and 5-bedroom homes ranging from 3,064 sq ft to 16,256 sq ft.

All residences have strong connections with natural elements. From the rustle of leaves to the rush of water, in Eywa you're never more than a step away from nature.

- ◆ Private Terraces with Dining Area and Hammocks
- ◆ Private Waterfalls and Pools
- ◆ Natural Stone & Engineered Wood Flooring
- ◆ Fully Customised and Sustainably Produced Kitchen Joinery
- ◆ Signature Stone Countertops
- ◆ European Kitchen Appliances with High Energy Rating
- ◆ European Sanitary Ware
- ◆ Generous Storage and Service Spaces



الرفاهية

DUBAI

BY R·EVOLUTION



LIVING ROOM



KITCHEN DINING

الرفاهية

DUBAI

BY R·EVOLUTION



MASTER BEDROOM

الواقية

DUBAI

BY EVOLUTION



MASTER BATHROOM

الرفاهية

DUBAI

BY REVOLUTION



APARTMENT TERRACE



مذاق

DUBAI

BY R•EVOLUTION

SERVICES & AMENITIES

Amenities Floor



Spa



Fitness Club and Yoga Studio

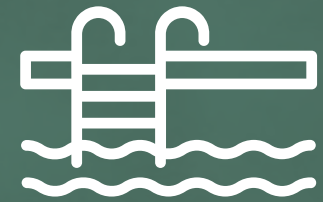

3 Swimming Pools



Massage & Treatment Rooms



Open-Air and Indoor Cinema



Crystal Garden



- Hammam
- Sauna & Experience Showers
- Cold Plunge Pool
- Relaxation Lounge



Children's Club, Montessori,
and STEAM-Lead Design
and Resources



Pool Deck, Outdoor Bar
and Changing Rooms



Salon, Hairdresser
and Nail Spa



Outdoor Playground
"Kids Workshop"



Omega Water Filtration System



- Private Clubhouse • Private Chef • Open Kitchen
- Catering Kitchen • Private Dining & Conference Facilities
- Library & Music Lounge

Eyeza

DUBAI

BY R•EVOLUTION

Entrance & Ground Floor



Private Drop Off & Valet



Double Height Lobby
with Library & Treehouse
Lounge Seating



Private Service and
Delivery Entrance



24/7
Concierge Service



Outdoor Lounge Seating
& Waterfalls



ASG Network Inside Building

عشاق

DUBAI

BY R•EVOLUTION

PAYMENT PLAN





بناشيا

DUBAI

BY R•EVOLUTION

REAL ESTATE

R•EVOLUTION

DEVELOPER

CONTACTS:

+971 54 308 6000
sales@byrevolution.com